



# 目 录

一、运输作业组织与管理模块..... 2

二、仓储与配送作业组织与管理模块..... 34

三、国际物流作业组织与管理模块..... 150

四、 快递物流作业组织与管理模块.....	213
-----------------------	-----

湖南商务职业技术学院物流管理专业学生技能考核题库

## 一、运输作业组织与管理模块

○

○

○

--	--	--

○

○

--	--	--	--	--

## ( ) 任务描述

- :
- 
-





<input type="checkbox"/> <input type="checkbox"/>				<input type="checkbox"/> <input type="checkbox"/>				
<input type="checkbox"/> <input type="checkbox"/>								
						<input type="checkbox"/> <input type="checkbox"/> <input type="checkbox"/> <input type="checkbox"/>		





( ) 任务描述:

- 
- 
- 





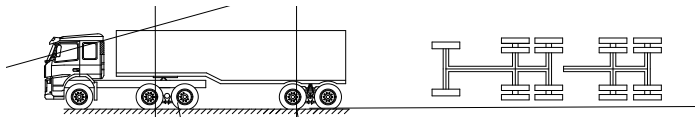
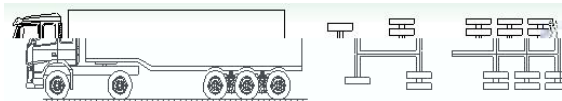

○

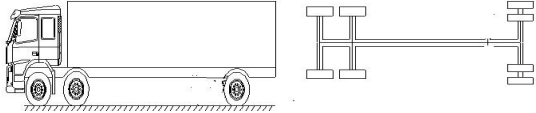
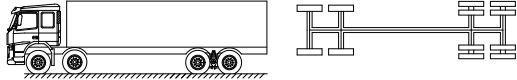
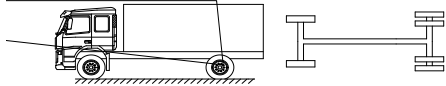
○

○

--	--	--	--	--

( ) 任务描述:







○

○

○

○

○





( ) 任务描述



**D**

<input type="checkbox"/> <input type="checkbox"/>			<input type="checkbox"/> <input type="checkbox"/>						
<input type="checkbox"/> <input type="checkbox"/>									
						<input type="checkbox"/> <input type="checkbox"/> <input type="checkbox"/> <input type="checkbox"/>			

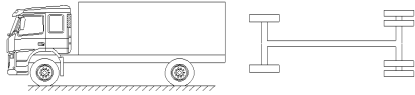
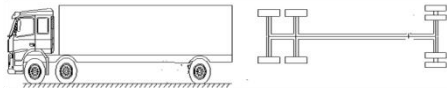
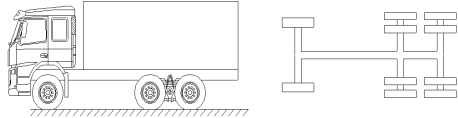



**2**



**3**

**4**



( ) 任务描述

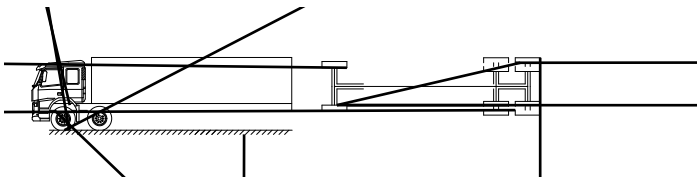
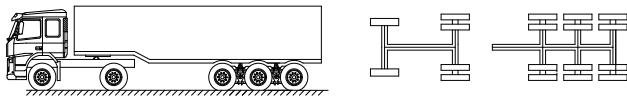
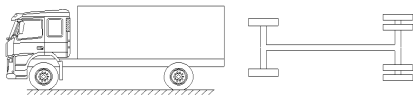







( ) 任务描述

- 
- 
- 
- 
- 





( ) 任务描述

( )

( )

		)	( )		

( )

( )

( )

( )

( )

○

( )			



Sailing Schedule from : Shenzhen,Shenzhen,Guangdong,China

To : Los Angeles,Los Angeles,CA,United States

Origin City : Shenzhen,Shenzhen,Guangdong,China

Destination City : Los Angeles,Los Angeles,CA,United States

CY/DOOR

CY/DOOR

序列号	航线	船名	航次	截关时间	装货港	预计离港时间	实际离港时间	卸货港
1	YPSW	YM UNISON	59E	2016-04-22 17:00	Yantian	2016-04-25		Los Angeles
2	SEA	NORTHERN JAVELIN	002E	2016-04-23 12:00	Yantian	2016-04-27		Long Beach
3	AAS2	CMA CGM LIBRA	095TXE	2016-04-25 16:00	Yantian	2016-04-28		Long Beach
4	YPSW	YM UBIQUITY	22E	2016-04-29 17:00	Yantian	2016-05-02		Los Angeles
5	SEA	C SCL PUSAN	117E	2016-04-30 12:00	Yantian	2016-05-04		Long Beach
6	AAS2	CMA CGM COLUMBA	097TXE	2016-05-02 16:00	Yantian	2016-05-05		Long Beach
7	SEA	COSCO NINGBO	069W	2016-05-06 11:00	Yantian	2016-05-08		Long Beach
8	YPSW	YM JIREBY	50E	2016-05-06 17:00	Yantian	2016-05-09		Los Angeles
9	SEA	COSCO EXCELLENCE	027E	2016-05-07 12:00	Yantian	2016-05-11		Long Beach
10	AAS2	CMA CGM CENTAURUS	099TXE	2016-05-09 16:00	Yantian	2016-05-12		Long Beach
11	YPSW	YM MASCULINITY	32E	2016-05-13 17:00	Yantian	2016-05-16		Los Angeles
12	SEA	HONG KONG BRIDGE	039E	2016-05-14 12:00	Yantian	2016-05-18		Long Beach
13	AAS2					2016-05-19		Long Beach



干货箱



	箱体内部尺寸			箱体内容积及载重量		箱门开度尺寸	
	L	W	H	Cu	P	W	H
20'	5898	2352	2393	33.2	21740/28230#	2340	2280
40'	12032	2352	2393	67.7	26630	2340	2280
HC	12032	2352	2698	76.3	26520	2340	2585

冷藏箱



	箱体内部尺寸			箱体内容积及载重量	
	L	W	H	Cu	P
20'	5444	2284	2267	28.5	21135/27160#
40'	11583	2284	2250	58.7	26580
HC	11583	2284	2609	67.9	26380

开顶箱

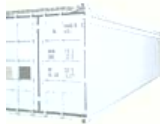

	箱体内部尺寸			箱体内容积及载重量	
	L	W	H	Cu	P
20'	5900	2330	2337	32.6	21740
40'	12025	2330	2337	65.8	26410

○

○

( ) 实施条件

( ) 考核时量

( ) 评分细则

1





( ) 任务描述



		<input type="checkbox"/>	<input type="checkbox"/>	<input type="checkbox"/>	<input type="checkbox"/>

□		□		
□		□		



( ) 实施条件



( ) 考核时量

( ) 评分细则





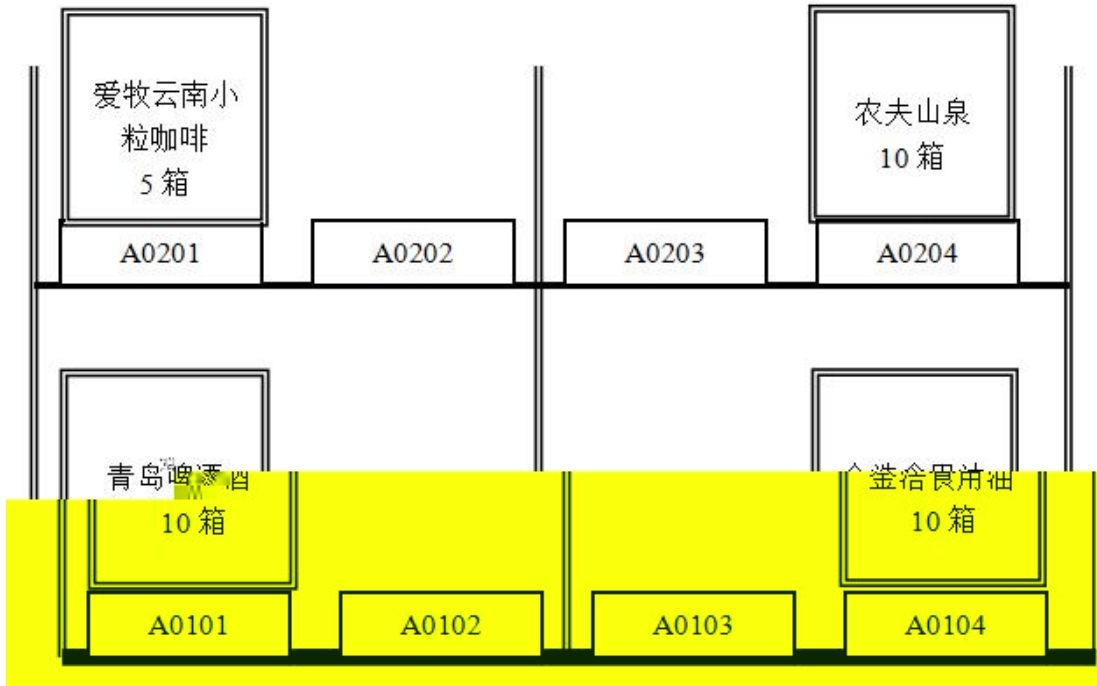



## 产品运输单

---



- 
- 
- 
- 
- 
- 
- 
-





80				





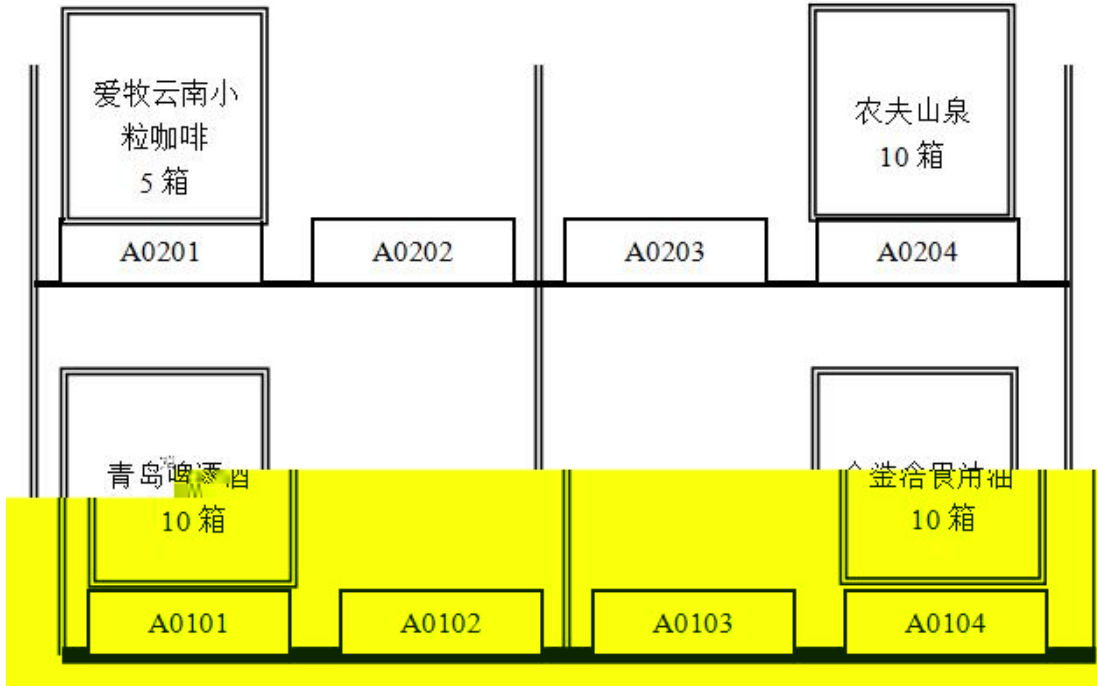



# 产品运输单

---



- 
- 
- 
- 
- 
- 
- 
- 









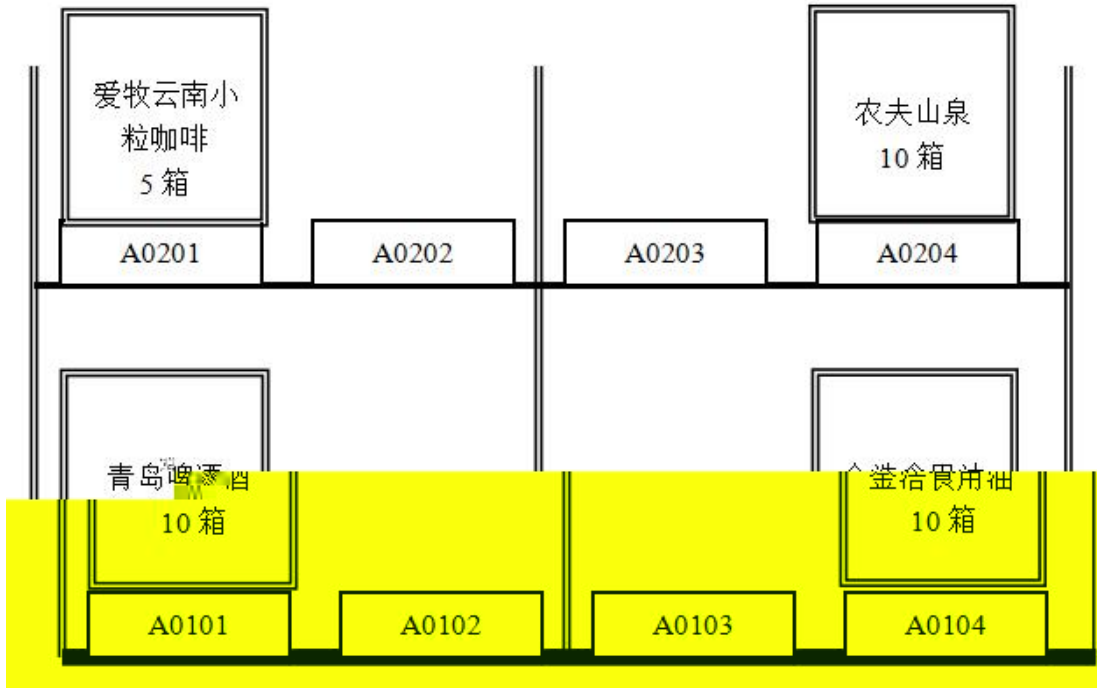

## 产品运输单

---



- 
- 
- 
- 
- 
- 
- 
-











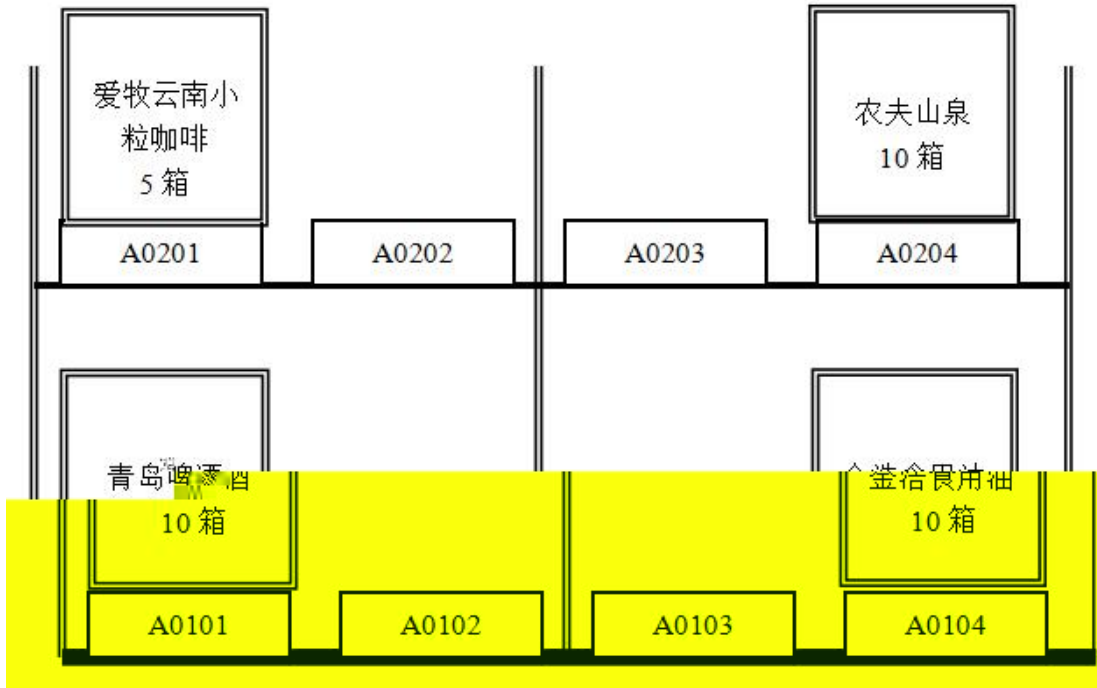

# 产品运输单

---



- 
- 
- 
- 
- 
- 
- 
-







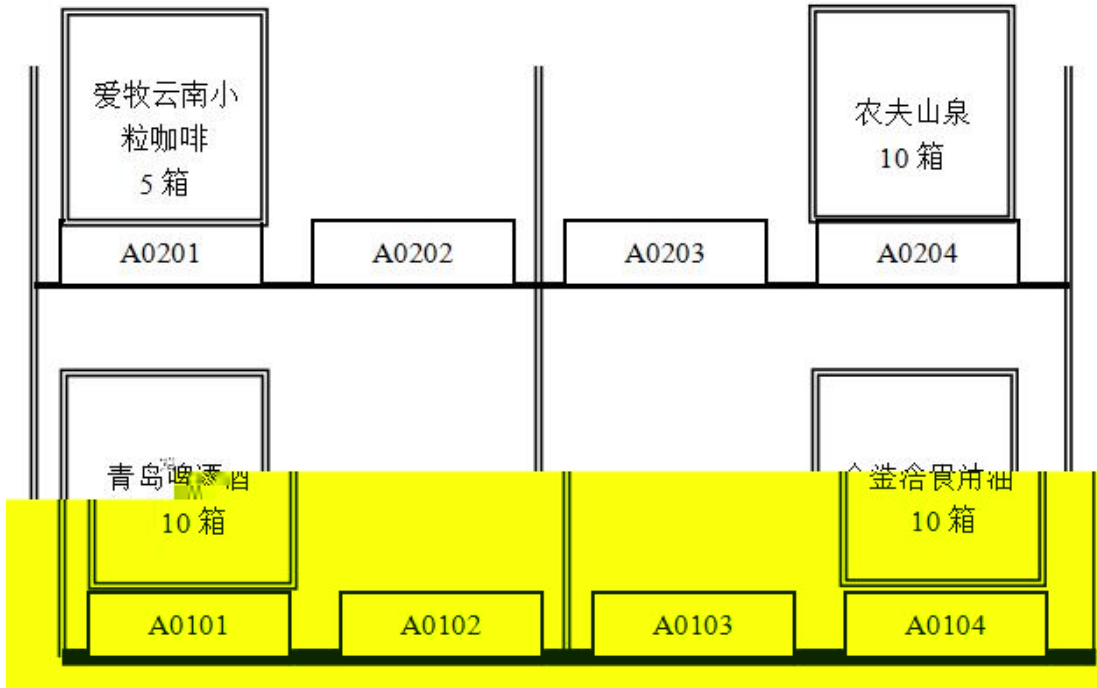



# 产品运输单

---

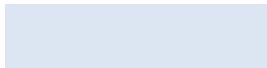

4040 Lö•D S \$









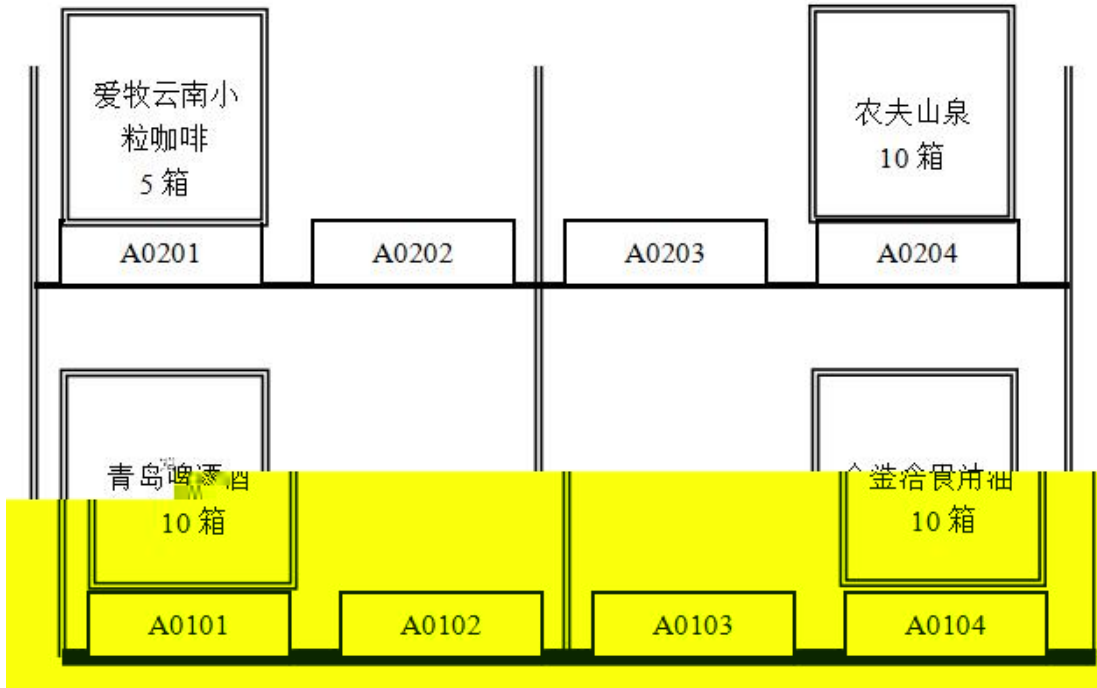

## 产品运输单











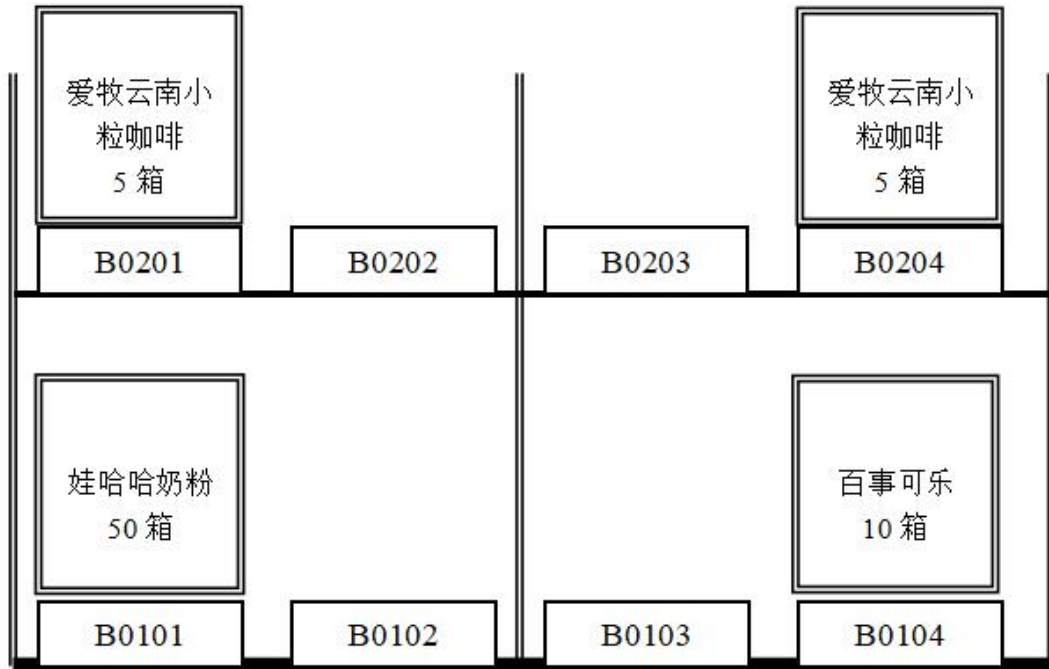
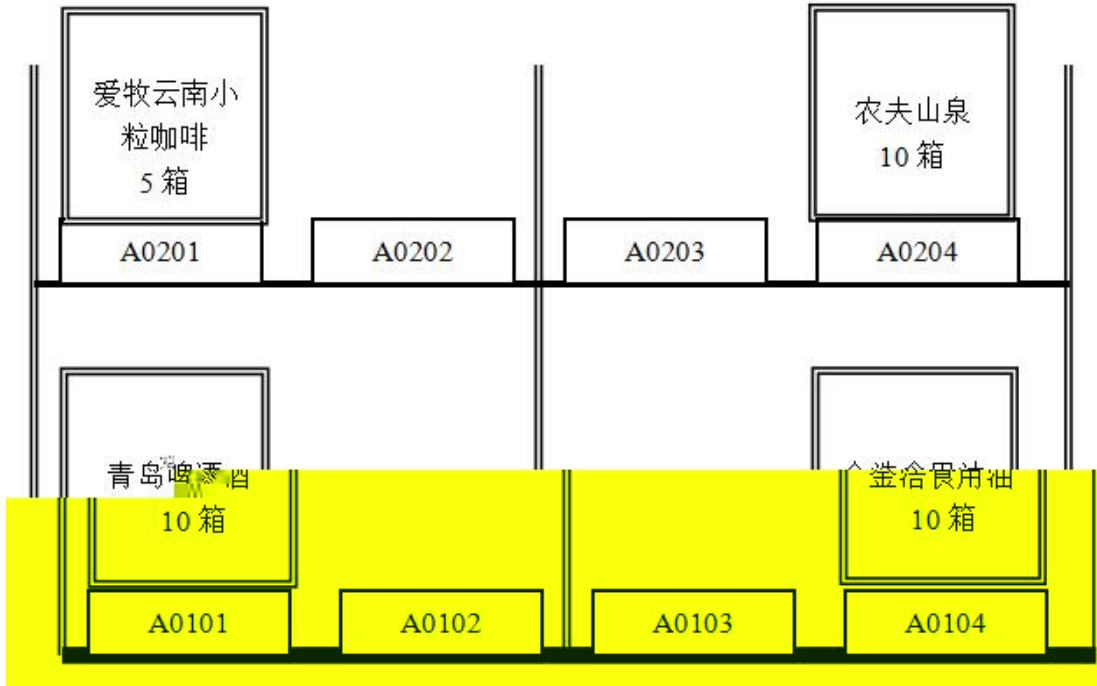

# 产品运输单

---



- 
- 
- 
- 
- 
- 
- 
- 
- 









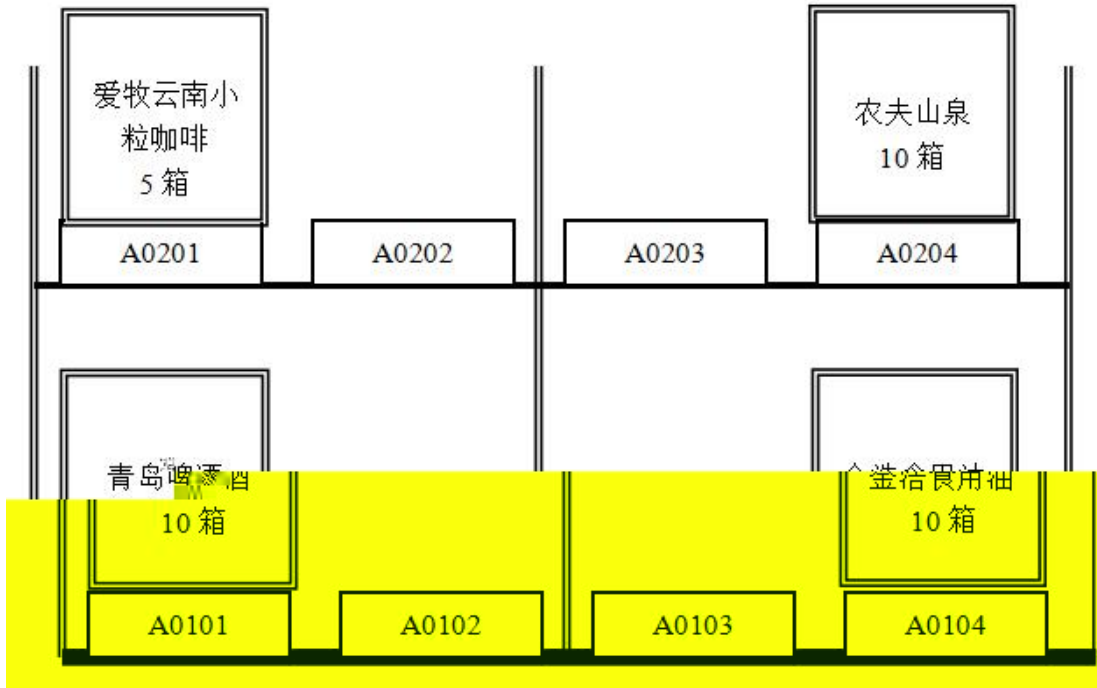

# 产品运输单

---



- 
- 
- 
- 
- 
- 
- 
- 
- 







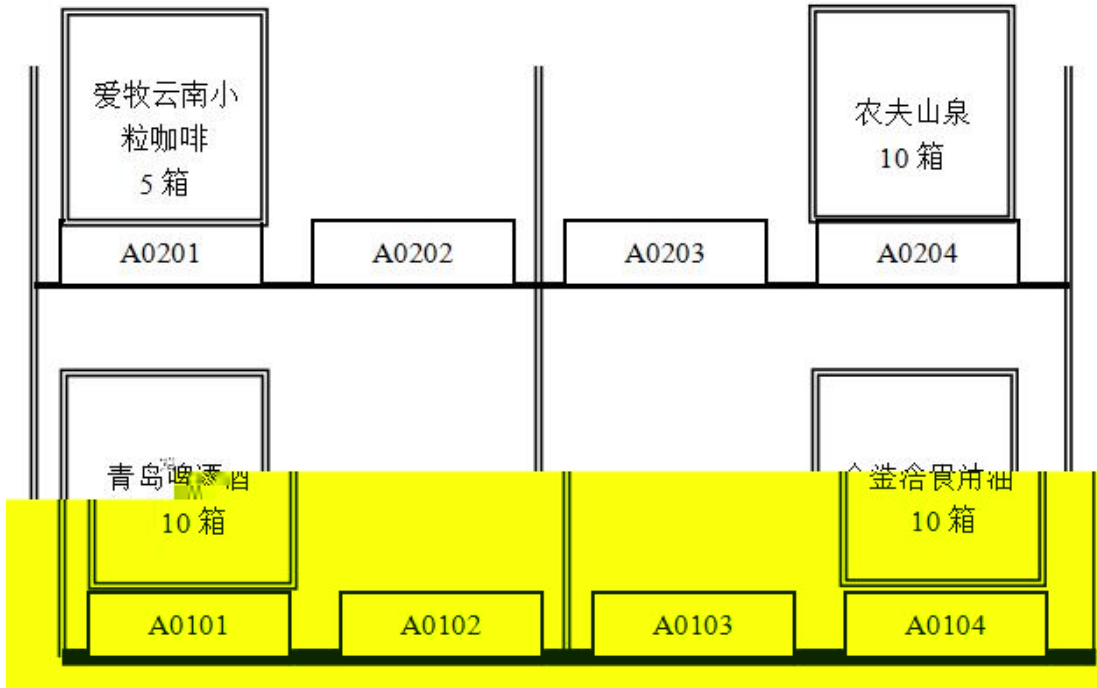

# 产品运输单

---



- 
- 
- 
- 
- 
- 
- 
-











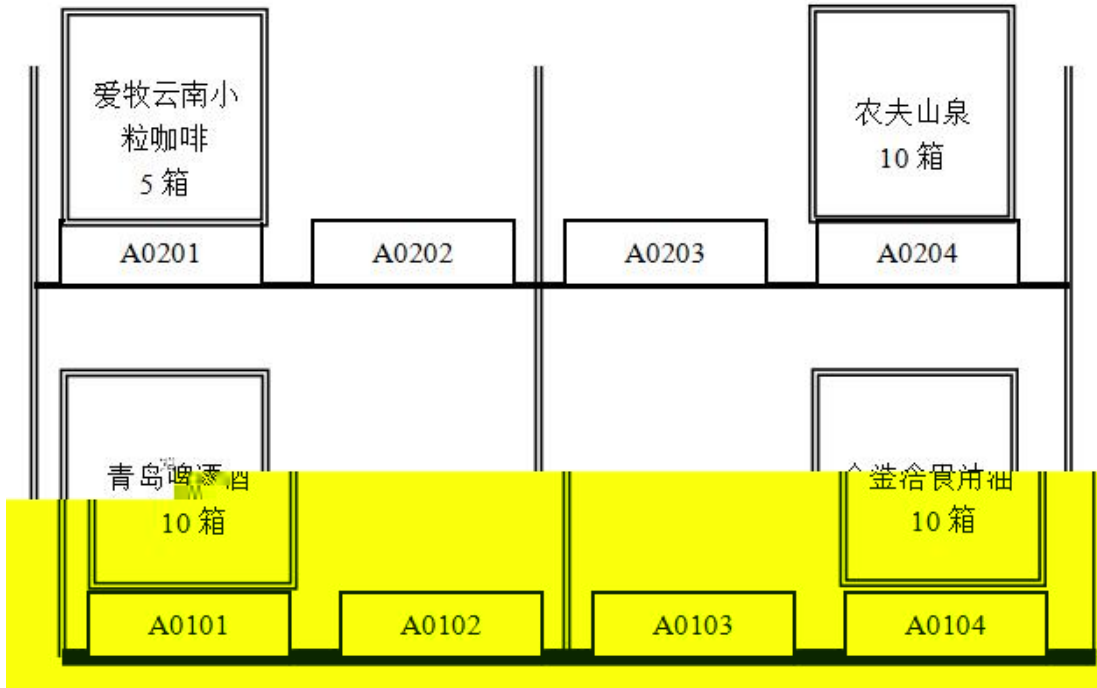

# 产品运输单

---



- 
- 
- 
- 
- 
- 
- 
- 







○

---



---



---

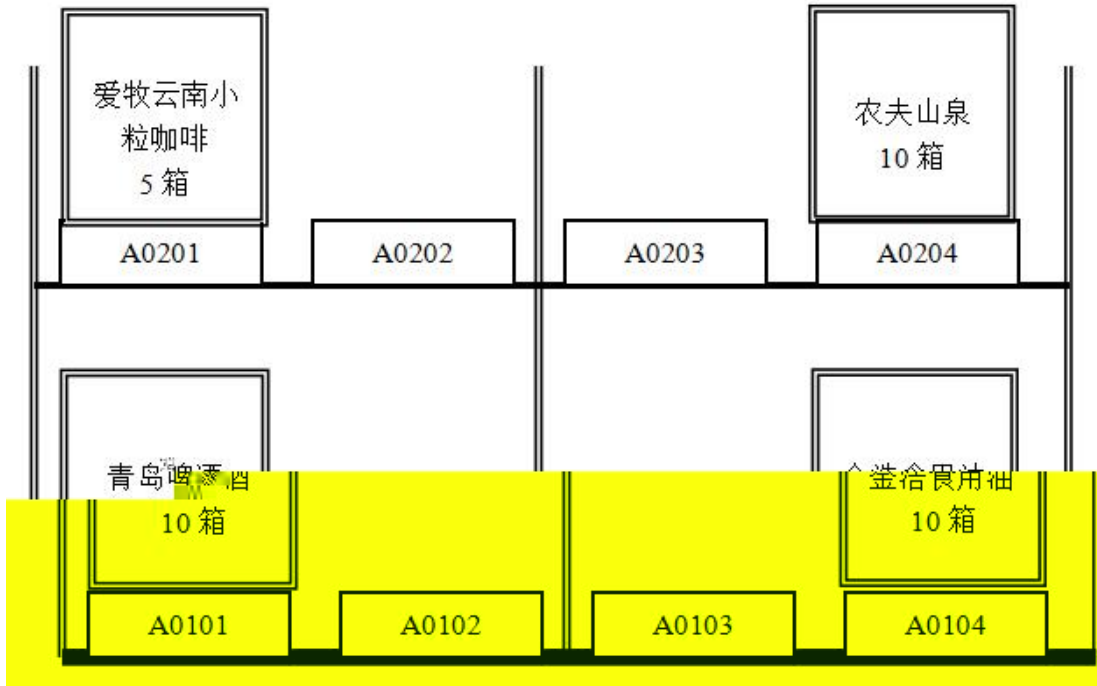





---

--	--	--	--	--	--

---



---

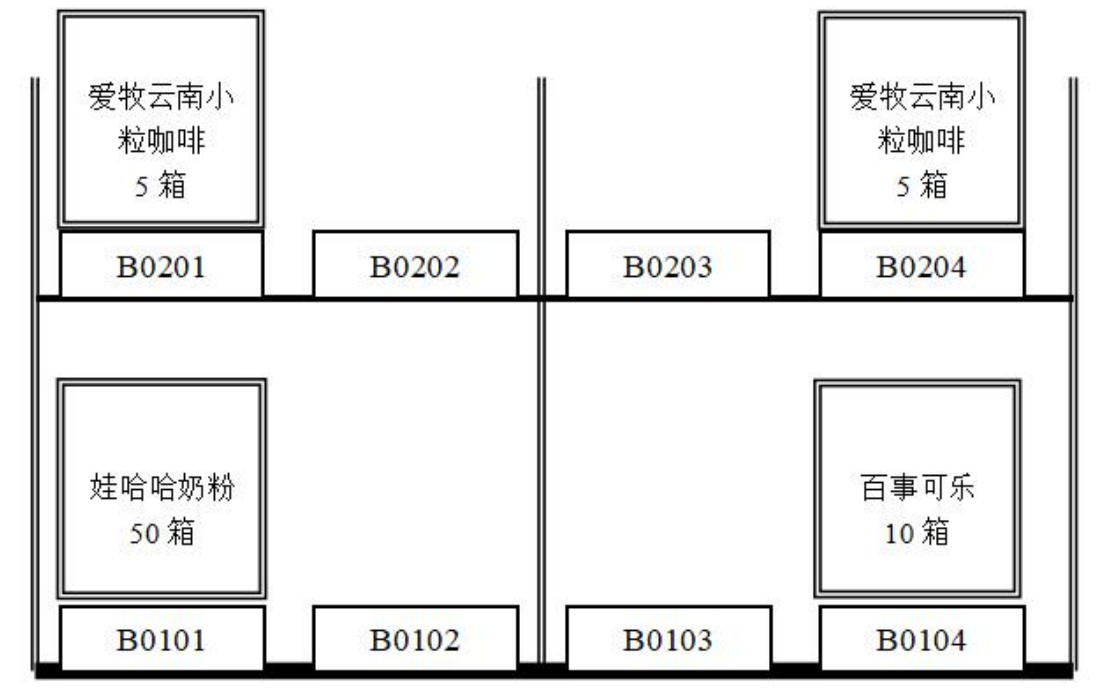
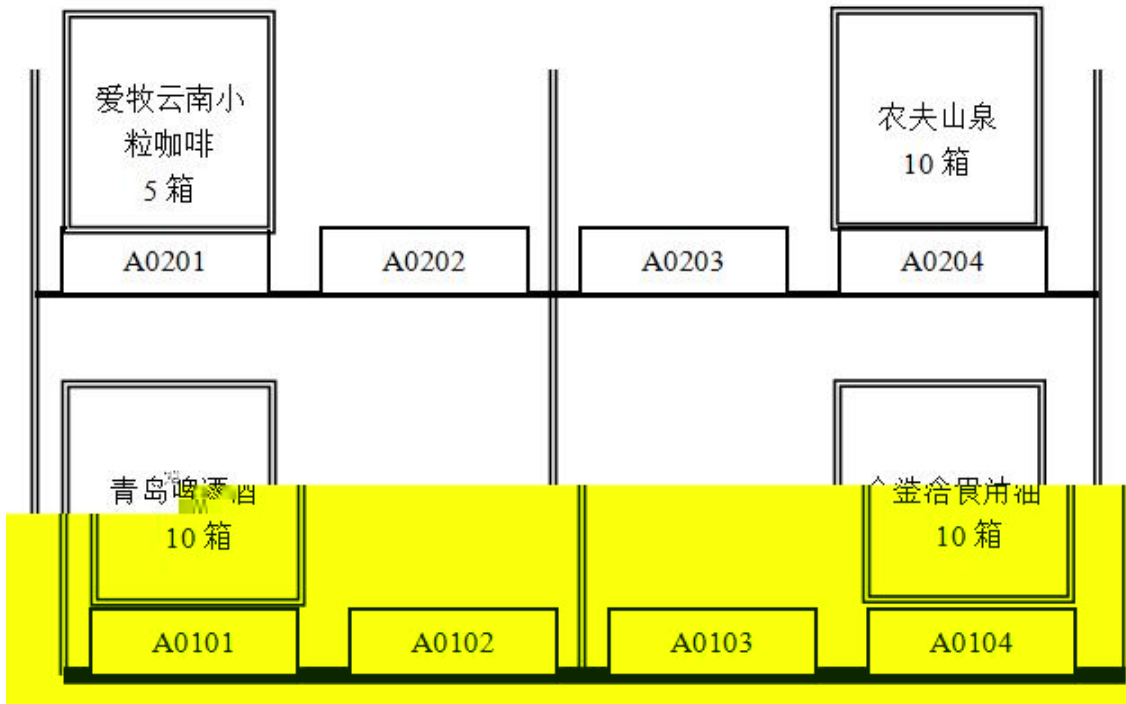

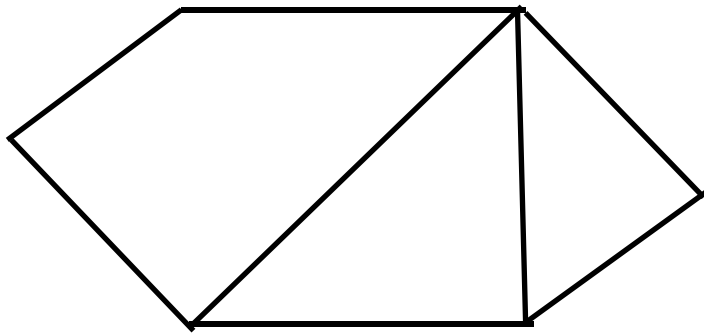







---

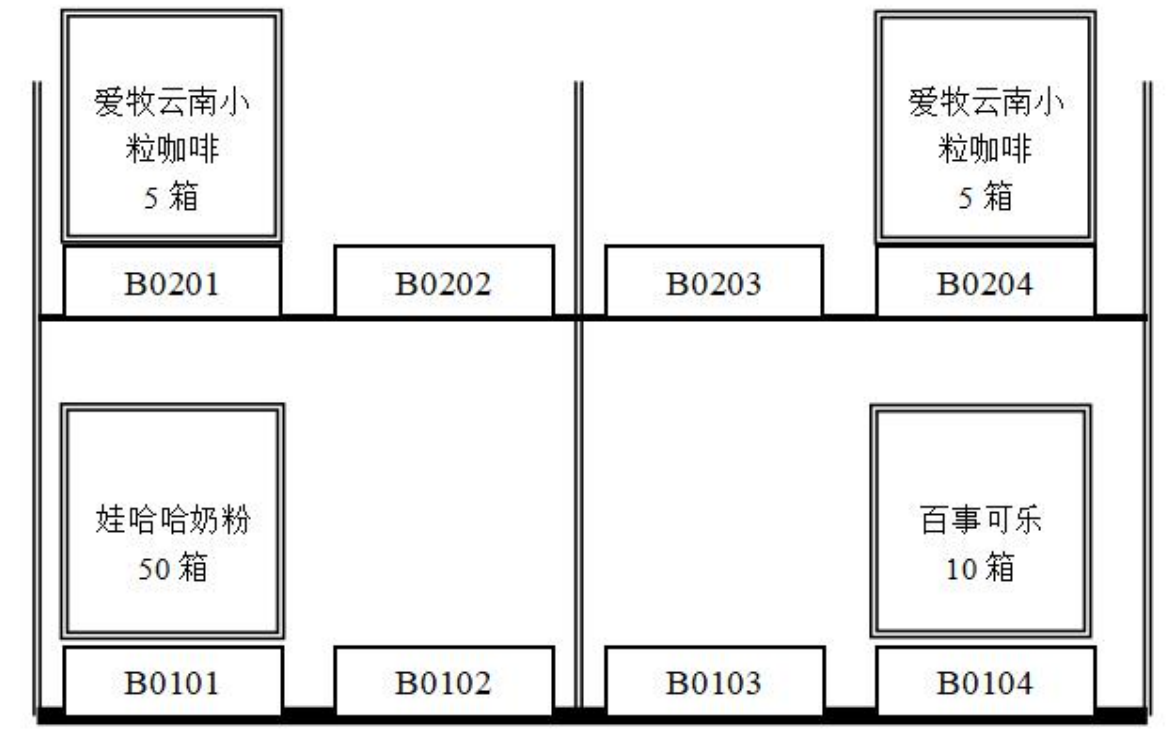
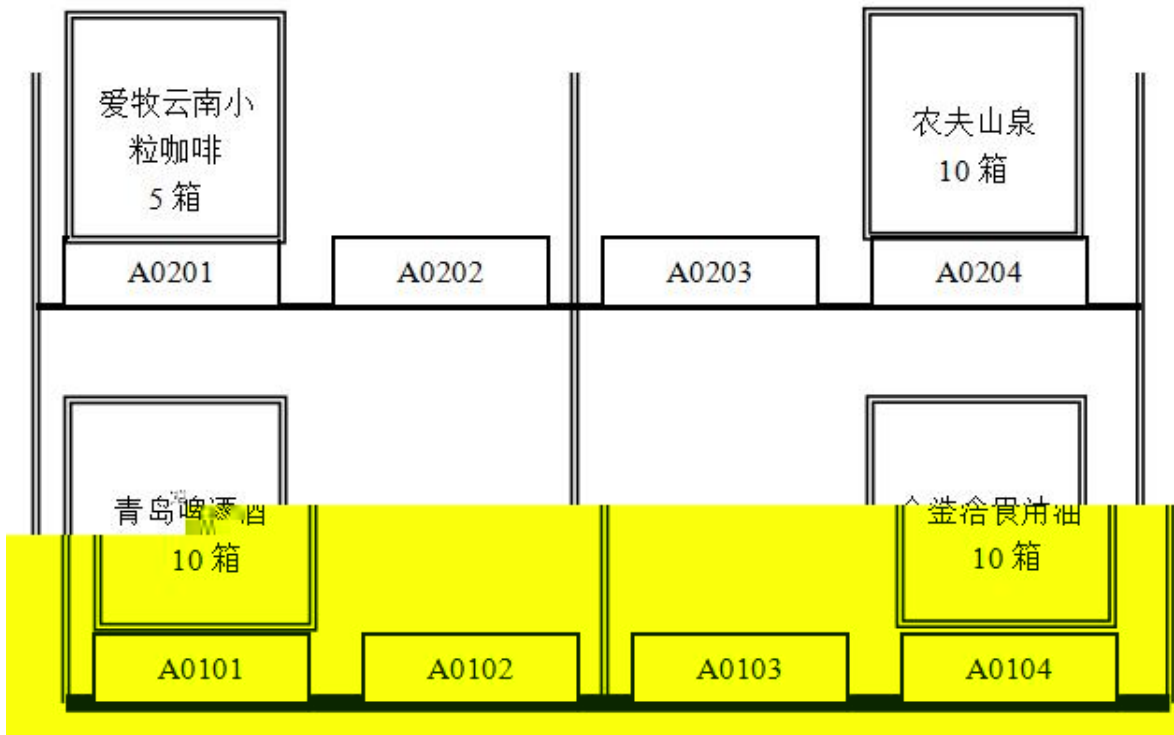

---







**1**

---



---



---



---



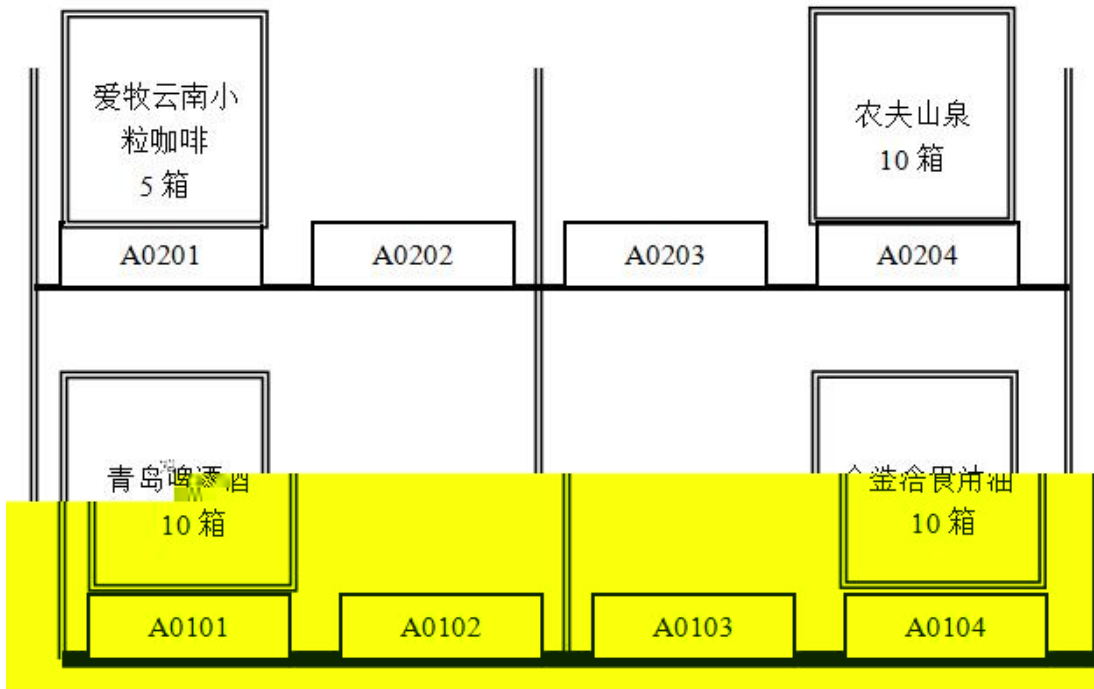





**1**

---

--	--	--	--	--	--

---



---

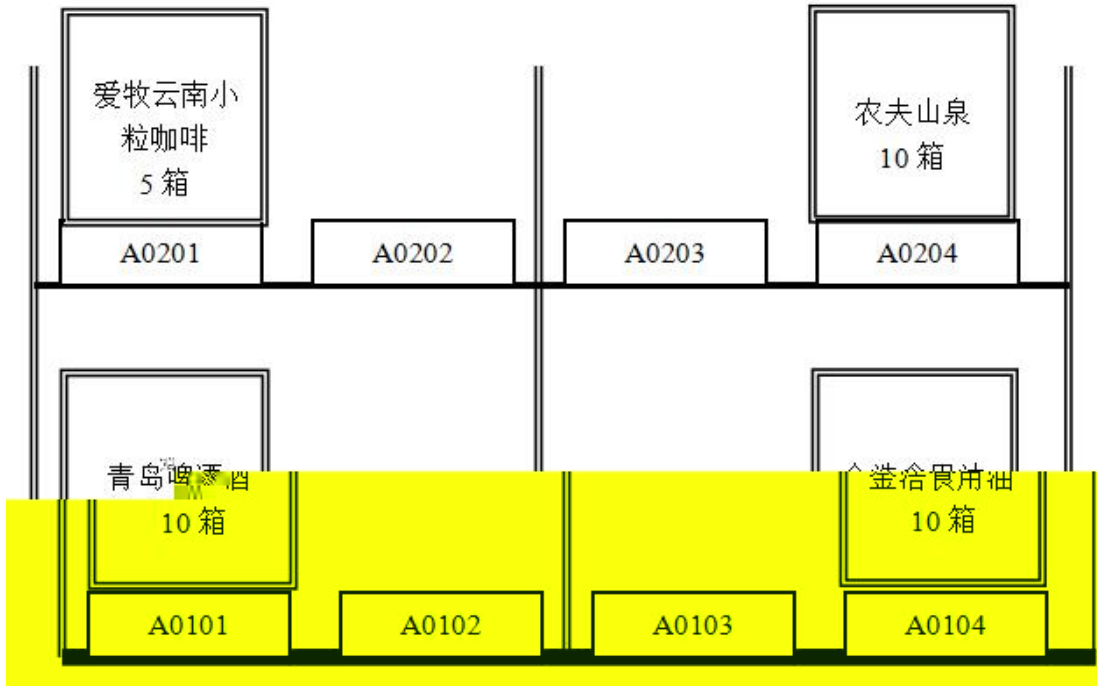











○

○













○

○











○

○













○

○

--	--











○

○







### 三、国际物流作业组织与管理模块



○



---

---

---

---





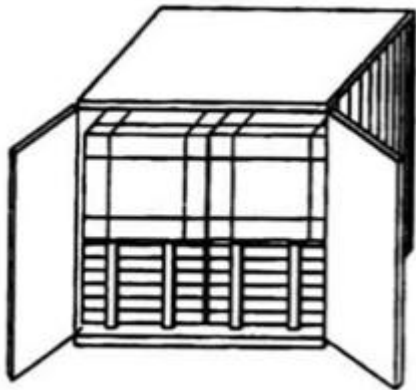
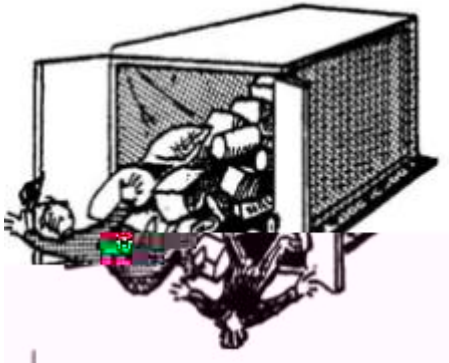
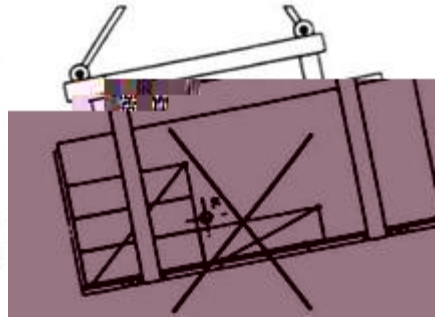





○







○  
○

<b>BEIJING</b>	<b>CN</b>		<b>BJ\$</b>
<b>Y. RENMINBI</b>	<b>CNY</b>		<b>KGS</b>
<b>BOSTON</b>	<b>US</b>	<b>M</b>	<b>630.00</b>
		<b>N</b>	<b>79.97</b>
		<b>45</b>	<b>60.16</b>
		<b>100</b>	<b>53.19</b>
		<b>300</b>	<b>45.80</b>

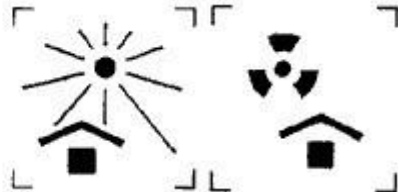



○





○

○







---

---

---

---

---

---

集装箱设备交接单  
EQUIPMENT INTERCHANGE RECEIPT

OUT 出场

No.

用箱人/运箱人(CNTR. USER/HAULIER)		提箱地点(PLACE OF DELIVERY)																
发往地点(DELIVERED TO)		返回/收箱地点(PLACE OF RETURN)																
船名/航次(VESSEL/VOYAGE No.)	集装箱号(CNTR. No.)	尺寸/类型(SIZE/TYPE)	营运人(CNTR. OPTR)															
提单号(B/L No.)	危险品类别(IMCO CLASS)	箱封号(SEAL No.)	危险货物(REFRIGERATED/PERISHABLE) 提单号(B/L No.) 船名/航次(VESSEL/VOYAGE No.) 集装箱号(CNTR. No.)															
货物(CARGO W.)	出场目的/状态(PPS OF GATE-OUT/STATUS)	进场目的/状态(PPS OF GATE-IN/STATUS)	出场日期(TIME-OUT) 月 日 时															
出场检查记录(INSPECTION AT THE TIME OF INTERCHANGE)																		
普通集装箱(GP. CNTR.)	冷藏集装箱(REF. CNTR.)	特种集装箱(SPL. CNTR.)	发电机(GEN. SET)															
<input type="checkbox"/> 正常(SOUND) <input type="checkbox"/> 异常(DEFFECTIVE)	<input type="checkbox"/> 正常(SOUND) 设定温度(SET) <input type="checkbox"/> 异常(DEFFECTIVE) 记录温度(RECORDED)	<input type="checkbox"/> 正常(SOUND) <input type="checkbox"/> 异常(DEFFECTIVE)	<input type="checkbox"/> 正常(SOUND) <input type="checkbox"/> 异常(DEFFECTIVE)															
损坏记录及代号(DAMAGE CODE)																		
<table border="0"> <tr> <td> BR 破损 (BROKEN)</td> <td> D 凹痕 (DENT)</td> <td> M 丢失 (MISSING)</td> <td> DR 污损 (DIRTY)</td> <td> DL 危标 (DGLABEL)</td> </tr> <tr> <td>左测(LLEFT SIDE) </td> <td>右测(RRIGHT SIDE) </td> <td>前测(FRONT) </td> <td colspan="2">内部(INSIDE) </td> </tr> <tr> <td>顶部(TOP) </td> <td>底部(FLOOR BASE) </td> <td>后测(REAR) </td> <td colspan="2">如有异状, 请注明程度及尺寸(REMARK)</td> </tr> </table>				BR 破损 (BROKEN)	D 凹痕 (DENT)	M 丢失 (MISSING)	DR 污损 (DIRTY)	DL 危标 (DGLABEL)	左测(LLEFT SIDE) 	右测(RRIGHT SIDE) 	前测(FRONT) 	内部(INSIDE) 		顶部(TOP) 	底部(FLOOR BASE) 	后测(REAR) 	如有异状, 请注明程度及尺寸(REMARK)	
BR 破损 (BROKEN)	D 凹痕 (DENT)	M 丢失 (MISSING)	DR 污损 (DIRTY)	DL 危标 (DGLABEL)														
左测(LLEFT SIDE) 	右测(RRIGHT SIDE) 	前测(FRONT) 	内部(INSIDE) 															
顶部(TOP) 	底部(FLOOR BASE) 	后测(REAR) 	如有异状, 请注明程度及尺寸(REMARK)															
除列明者外, 集装箱设备交接时完好无损, 箱封完整无误。 EQUIPMENT INTERCHANGED IN SOUND CONDITION AND SEAL INTACT UNLESS OTHERWISE STATED		CONTAINER EQ 用箱人/运箱人签署 (CONTAINER USER/HAULIER'S SIGNATURE)																
码头/堆场值班员签署 (TERMINAL/DEPOT CLERK'S SIGNATURE)		年 月 日																
年 月 日		年 月 日																

GB/T 16561-1996 格式印制











--	--	--	--	--	--

















--	--	--



--	--	--	--	--	--





--	--	--	--	--	--

--	--	--	--	--	--	--	--

○













\*6



#AIC 2024











○

--	--	--











--	--	--	--	--	--

○

○

○



○







#### 四、 快递物流作业组织与管理模块























--	--	--	--	--	--

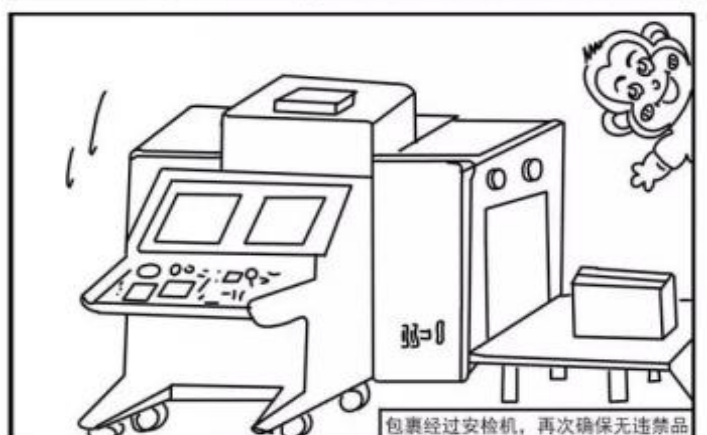
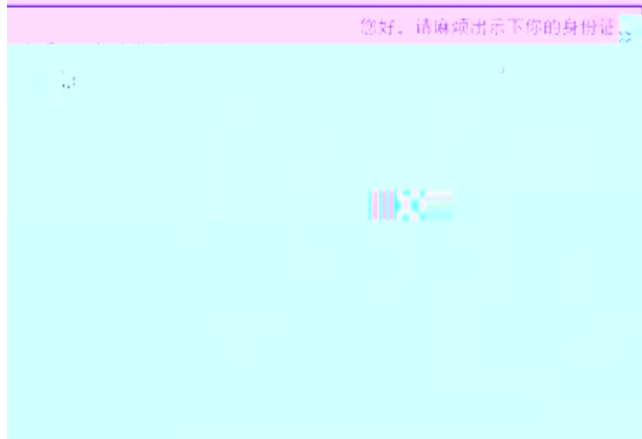
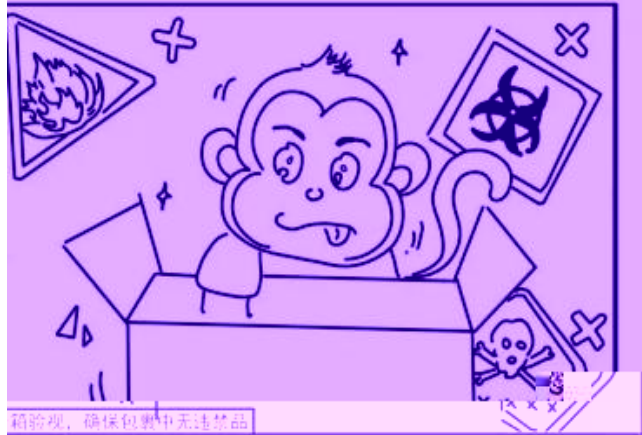



--	--	--	--	--	--















---





--	--	--	--	--	--



[想知道:中国成都理工大学校园快递具体在哪? 百度知道](#)

3个回答 - 提问时间: 2014年02月10日

最佳答案  均在银杏后面。宝盒、圆通、顺丰在电影院后面。中通、申通在图书馆下面。常用的是这几个。

[zhidao.baidu.com/link?...](http://zhidao.baidu.com/link?...) 2014-02-15 - 百度快照 - 80%好评



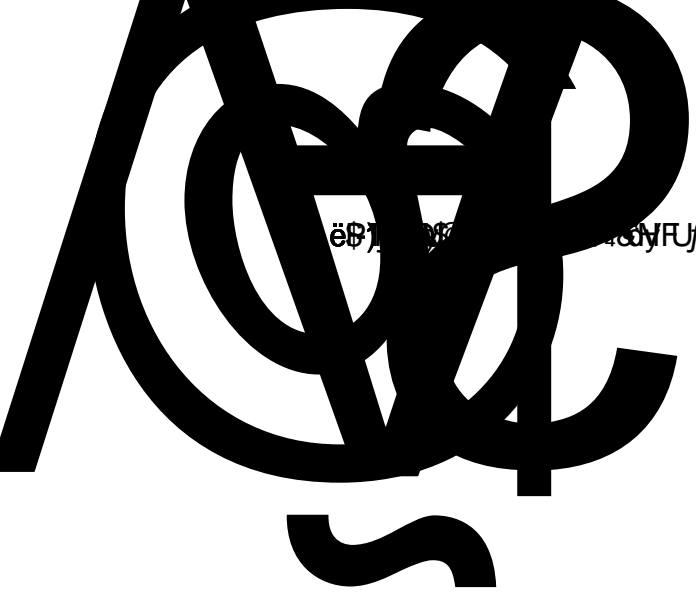

ëÞ) 97 4yFJ9\$ ã@D@X? 3\*EBl@ \$H 9h

















--	--	--	--

















--	--	--	--













1



































































--

